

# Wallbox Pulsar Plus

Intelligent car charging system

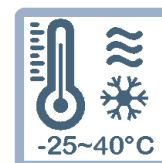

- ✓ Compact design
- ✓ Suitable for any installation, in private garages or shared parking lots
- ✓ Smart charging for electric and plug-in hybrid vehicles
- ✓ MyWallbox app, check the charging status even remotely
- ✓ Apple App Store, Google Play, smartwatch
- ✓ Charging power up to 7.4kW (single phase)
- ✓ Integrated 5m charging cable
- ✓ Compatible with Type 1 or Type 2 electric vehicles
- ✓ Wifi & Bluetooth connectivity
- ✓ OCPP compatible

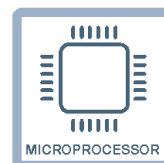
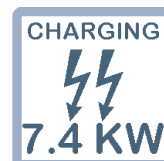
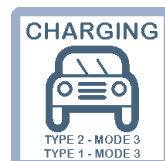



## Technical features

<b>General Specifications</b>	<b>Model</b>	Pulsar Plus
	<b>Colour</b>	White
	<b>Cable Length</b>	5 m
	<b>Charging Mode</b>	Mode 3 (IEC 61851-1)
	<b>Dimensions</b>	166x163x82 mm (without cable)
	<b>Weight</b>	1 kg (without cable)
	<b>Operating Temp.</b>	-25 °C to 40 °C
	<b>Storage Temp.</b>	-40 °C to 70 °C
	<b>Standards</b>	CE mark LVD 2014/35/EU, EMC 2014/30/EU IEC61851-1, IEC61851-22, IEC62196-2, BS7671:2018
	<b>Electrical Specifications</b>	<b>Charging Power</b>
<b>Rated Voltage</b>		230V AC ± 10%
<b>Rated Current</b>		32A (1P)
<b>Connector Type</b>		Type 1 or Type 2 (See ordering code)
<b>Cable Width</b>		up to 3x 10 mm <sup>2</sup>
<b>Config. Current</b>		from 6 A to rated current
<b>Rated Frequency</b>		50 Hz / 60 Hz
<b>Protection Rating</b>		IP54 / IK08
<b>Surge Category</b>		CAT III
<b>Residual Current Detection</b>		DC 6mA Internal RDC-DD meets tripping time characteristics according to IEC 62955.
<b>RCCB</b>		External RCCB required
		Type A or Type B according to local regulations
<b>User Interface &amp; Communications</b>	<b>Connectivity</b>	Wi-Fi, Bluetooth
	<b>User Identification</b>	myWallbox App & Portal
	<b>User Interface</b>	myWallbox App & Portal
	<b>Charger Status Information</b>	Halo RGB LED, myWallbox App & Portal
	<b>Included Features</b>	Power Sharing Smart
	<b>Other Features</b>	Power Boost
<b>Ordering code</b>	<b>CNWALLBOX-P-01A-00</b>	PulsarPlus 7,4KW, Type2, 5mt, Powerboost, White Type 2 (IEC 62196-2)
	<b>CNWALLBOX-P-01B-00</b>	PulsarPlus 7,4KW, Type1, 5mt, Powerboost, White Type 1 (SAE J1772)

Doc Ref. ZST-4292-00000118-02

### Type 1

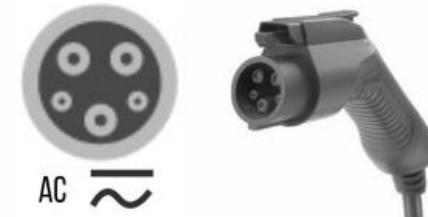

### Type 2





Scan me



**Intercomp S.p.A.**  
Via della Scienza 27, 37139, Verona, Italia  
Tel +39 045-8378411 Fax +39 045-8510539  
[www.intercomp.it](http://www.intercomp.it) [intercomp@intercomp.it](mailto:intercomp@intercomp.it)



The product may differ from the images shown. All registered names and trademarks are legitimate owners. All features and specifications can be changed without prior notice.  
Last update 30/11/2021



## Mechanical features

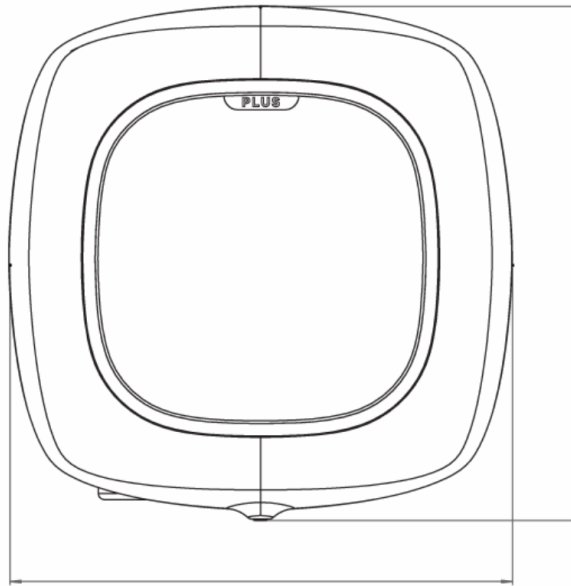

166 mm

163 mm

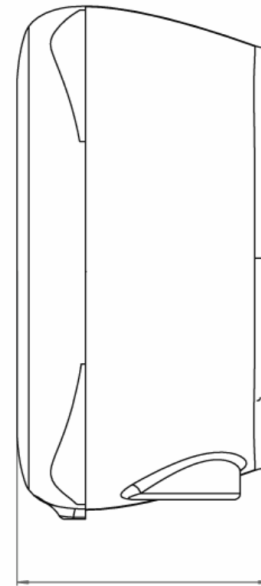

82 mm

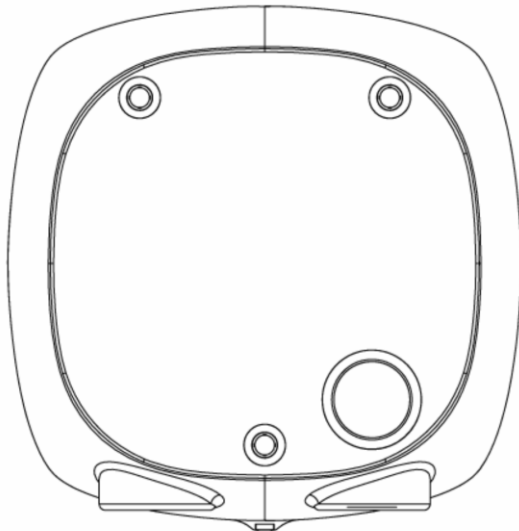

All dimensions are expressed in millimeters (mm)



Scan me



**Intercomp S.p.A.**  
Via della Scienza 27, 37139, Verona, Italia  
Tel +39 045-8378411 Fax +39 045-8510539  
[www.intercomp.it](http://www.intercomp.it) [intercomp@intercomp.it](mailto:intercomp@intercomp.it)



The product may differ from the images shown. All registered names and trademarks are legitimate owners. All features and specifications can be changed without prior notice.  
Last update 30/11/2021